

# Year 5: Maths Knowledge Mat

## Rounding

**78,543**

To the **nearest 10** is 78,540  
 To the **nearest 100** is 78,500  
 To the **nearest 1000** is 79,000  
 To the **nearest 10,000** is 80,000  
 To the **nearest 100,000** is 100,000

**67.53**

To the **nearest 10** is 70  
 To the **nearest whole number** is 68  
 To **one decimal place** is 67.6

## Multiplying a fraction by a whole number

If you have a **proper** fraction multiplied by a whole number, it is going to be **less** than that whole number

$$\frac{3}{5} \times 2$$

$$\frac{3}{5} \times \frac{2}{1} = \frac{6}{5} = 1 \frac{1}{5}$$

## Prime Numbers

1	2	3	4	5	6	7	8	9	10
11	12	13	14	15	16	17	18	19	20
21	22	23	24	25	26	27	28	29	30
31	32	33	34	35	36	37	38	39	40
41	42	43	44	45	46	47	48	49	50
51	52	53	54	55	56	57	58	59	60
61	62	63	64	65	66	67	68	69	70
71	72	73	74	75	76	77	78	79	80
81	82	83	84	85	86	87	88	89	90
91	92	93	94	95	96	97	98	99	100

## Prime factors

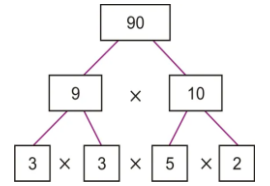

## Converting a mixed number to an improper fraction

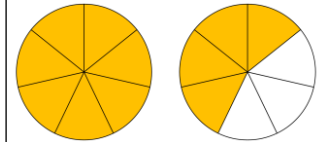

$$1 \frac{4}{7} = \frac{11}{7}$$

## Percentages %

'part per hundred' 50% =  $\frac{50}{100}$  25% =  $\frac{25}{100}$

50% of 100 = 50    25% of 100 = 25  
 50% of 200 = 100    25% of 200 = 50  
 50% of 300 = 150    25% of 300 = 75

$$\frac{1}{2} = 0.5 = 50\% \quad \frac{1}{4} = 0.25 = 25\%$$

$$\frac{1}{5} = 0.2 = 20\% \quad \frac{2}{5} = 0.4 = 40\%$$

## Place value

Each row divides by 10

	Tens	Ones	.	tenths	hundredths	thousandths
36.7	3	6	.	7	0	0
3.67	0	3	.	6	7	0
0.367	0	0	.	3	6	7

$$36.7 = 36 \frac{7}{10}$$

$$3.67 = 3 \frac{67}{100}$$

$$0.367 = \frac{367}{1000}$$

## Formal methods of multiplication and division

3741 x 6 becomes

$$\begin{array}{r} 3741 \\ \times 6 \\ \hline 22446 \\ \hline 42 \end{array}$$

485 ÷ 11 becomes

$$\begin{array}{r} 44 \text{ r}1 \\ 11 \overline{)485} \\ \underline{44} \phantom{0} \\ 48 \phantom{0} \\ \underline{44} \phantom{0} \\ 48 \phantom{0} \\ \underline{44} \phantom{0} \\ 48 \phantom{0} \\ \underline{44} \phantom{0} \\ 48 \phantom{0} \\ \underline{44} \phantom{0} \\ 48 \phantom{0} \\ \underline{44} \phantom{0} \\ 48 \phantom{0} \\ \underline{44} \phantom{0} \\ 48 \phantom{0} \\ \underline{44} \phantom{0} \\ 48 \phantom{0} \\ \underline{44} \phantom{0} \\ 48 \phantom{0} \end{array}$$

37 x 26 becomes

$$\begin{array}{r} 2 \\ 37 \\ \times 26 \\ \hline 222 \\ 740 \\ \hline 962 \end{array}$$

134 x 27 becomes

$$\begin{array}{r} 2 \quad 2 \\ 134 \\ \times 27 \\ \hline 938 \\ 2680 \\ \hline 3618 \end{array}$$

## Square and cubed numbers

$$\begin{aligned} 1^2 &= 1 \times 1 = 1 \\ 2^2 &= 2 \times 2 = 4 \\ 3^2 &= 3 \times 3 = 9 \\ 4^2 &= 4 \times 4 = 16 \\ 5^2 &= 5 \times 5 = 25 \\ 6^2 &= 6 \times 6 = 36 \\ 7^2 &= 7 \times 7 = 49 \\ 8^2 &= 8 \times 8 = 64 \\ 9^2 &= 9 \times 9 = 81 \\ 10^2 &= 10 \times 10 = 100 \end{aligned}$$

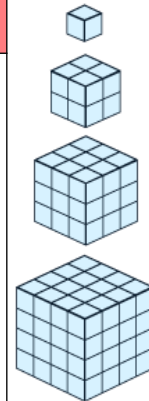

- 1 is the first cube number, because  $1 \times 1 \times 1 = 1$
- 8 is the second cube number, because  $2 \times 2 \times 2 = 8$
- 27 is the third cube number, because  $3 \times 3 \times 3 = 27$
- 64 is the fourth cube number, because  $4 \times 4 \times 4 = 64$

# Year 5: Maths Knowledge Mat

## Measures – Sticky Knowledge



1 km = 1000 m  
1 m = 100 cm  
1 cm = 10 mm



1 kg = 1000 g



1 l = 1000 ml

### Imperial measures

1 mile = 1.6 km  
1 yard = 9.1 m  
1 foot = 30 cm  
1 inch = 2.54 cm

1 lb (pound) = 0.45 kg

1 pint = 0.57 litre

## Perimeter

This must be 4 cm (10cm – 6cm)

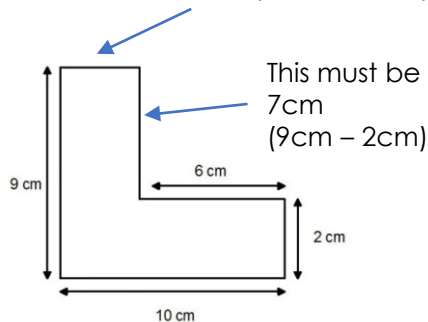

## Angles

**Right angle**  
Exactly 90°



**Straight line**  
= 180°



**Complete turn**  
= 360°

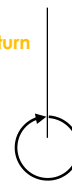

**Acute angle**  
Less than 90°

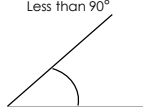

**Obtuse angle**  
Between 90° and 180°

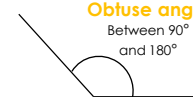

**Reflex angle**  
greater than 180°



## 3D Shapes

Solid (3D) shapes are three-dimensional shapes having length, breadth and height.

### Examples



sphere



cone



cylinder



cube

### Prisms



triangular prism



square prism



rectangular prism



pentagonal prism



hexagonal prism



octagonal prism

### Pyramids



triangular pyramid



square pyramid



rectangular pyramid



pentagonal pyramid



hexagonal pyramid



octagonal pyramid

### Platonic solids



tetrahedron



cube



octahedron



dodecahedron



icosahedron

## Roman Numerals

Symbol	Value
I	1
V	5
X	10
L	50
C	100
D	500
M	1000

### Dates

2020 = MMXX  
2021 = MMXXI  
2022 = MMXXII  
2023 = MMXXIII  
2024 = MMXXIV

1066 = MLXVI

1939 = MCMXXXIX

## Using a protractor

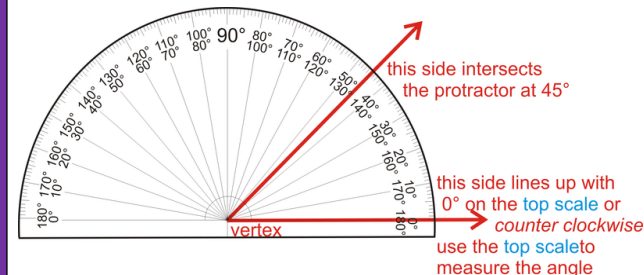

## Coordinates

P has been reflected in the x axis

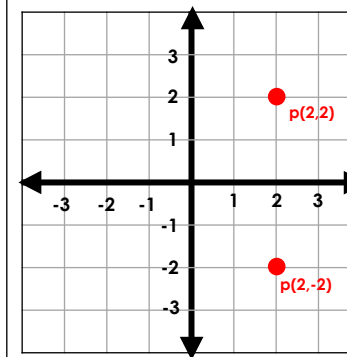

The shape has been reflected in the dotted line  $y=x+2$

